

freud.

**Circular Saw Blades
Kružne testere**

Catalogue 2018/19 - Katalog 2018/19



Your productive partner Vaš pouzdan partner

Premium quality industrial tools for superior efficiency

Industrijski alati vrhunskog kvaliteta za maksimalnu efikasnost



A wide range of top performing products

An extensive variety of precise and high-tech tools.

- Circular Saw Blades: the biggest manufacturer of high quality saw blades worldwide.
- Cutterheads and Brazed Cutters: freud sets the highest standard in the wood industry and window tooling.
- Knives, Spare parts and Accessories: in-house production of all Carbide inserts, unique in the world.
- Drilling, Routing & CNC Tools: a complete range for all applications.

Široka gama vrhunskih proizvoda

Veliki izbor preciznih i modernih alata.

- Kružne testere: najveći proizvođač visokokvalitetnih testera na svetu.
- Glodala sa izmenjivim i lemljenim pločicama: FREUD postavlja najviše standarde u drvoju i industriji prozora.
- Pločice, rezervni delovi i dodaci: FREUD je jedinstven u svetu po proizvodnji svih karbidnih elemenata u okviru kuće.
- Alati za CNC: kompletna gama za sve aplikacije.



A wide range of industrial cutting tools.
Široka gama industrijskih alata za rezanje.

GATECH
www.freud.rs

High quality solutions for your applications

Engineering competence and manufacturing know-how.

- Customized-to-Order: products to match special production needs.
- Enhanced technologies: Silver I.C.E., Perma-SHIELD, EXrim, ISOprofil, High Speed ISOprofil and Split-Edge.

Visokokvalitetna rešenja za Vaše aplikacije

Stručnost u konstruisanju i proizvodnji.

- Specifični zahtevi: proizvodi po specijalnim zahtevima proizvodnje.
- Napredne tehnologije: Silver I.C.E, Perma-SHIELD, EXrim, ISOprofil, High Speed ISOprofil i Split-Edge.



Advanced engineering and technology.
Napredno projektovanje i tehnologija.

Global services wherever you are

A belief in "think global and act local".

- Our worldwide subsidiaries and partners in over 90 countries ensure an extensive service and distribution network.
- Since 2009 freud is part of Bosch group, leveraging the global network of the world leading technology supplier.

Globalna usluga gde god da se nalazite

Verovanje u "misli globalno, radi lokalno".

- Naši agenti i partneri širom sveta u preko 90 zemalja osiguravaju dobru uslugu i distribuciju.
- Od 2009. godine FREUD je deo BOSCH grupe, čineći globalnu mrežu vodećeg svetskog dobavljača tehnoloških proizvoda.

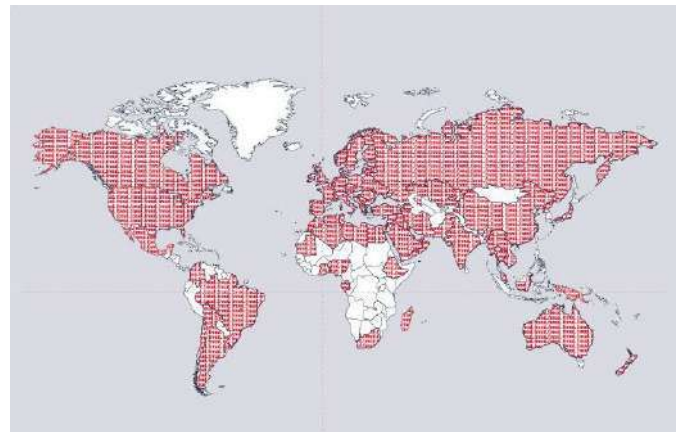

Worldwide presence.
Prisutnost širom sveta.

Advanced technology Napredna tehnologija

Innovative solutions to maximize
your investments

Inovativna rešenja
za maksimizaciju Vaših investicija

In-house Tungsten Carbide (HW) production

- TiCo Carbide is a specially formulated, highly compact Titanium Cobalt Carbide, engineered and manufactured in-house by Freud.
- Special HW grades are mixed based on application needs and checked according to strict quality criteria.
- Special tooth geometries are developed for perfect cuts.

Proizvodnja Tungsten Karbida (HW) "u kući"

- TiCo Karbid je specijalna formula, visokokompaktna verzija Titanijum Kobalt Karbida, stvorena i proizvedena "u kući" od strane FREUD-a.
- Specijalne klase HW mešaju se po potrebi i proveravaju po striktnim kriterijumima kvaliteta.
- Specijalna geometrija zuba razvijena je da bi se omogućio savršen rez.

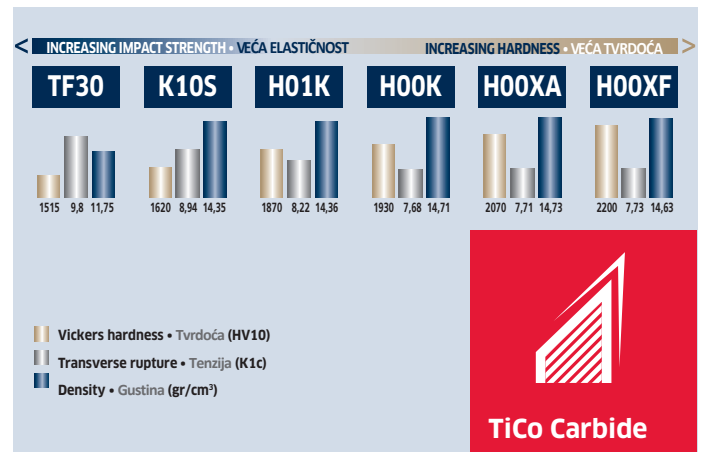

Overview of different standard HW grades.
Tablica različitih standardnih HW klasa.

GATECH
www.freud.rs

Multiple sharpenings: super square tooth design

- Tip thickness 30% greater than standard tips.
- Up to 25 sharpenings to extend the product life-time.

Višetruga oštrenja: superkvadratni zub

- Debljina vrha 30% veća od standardne.
- Do 25 oštrenja i znatno duži radni vek alata.

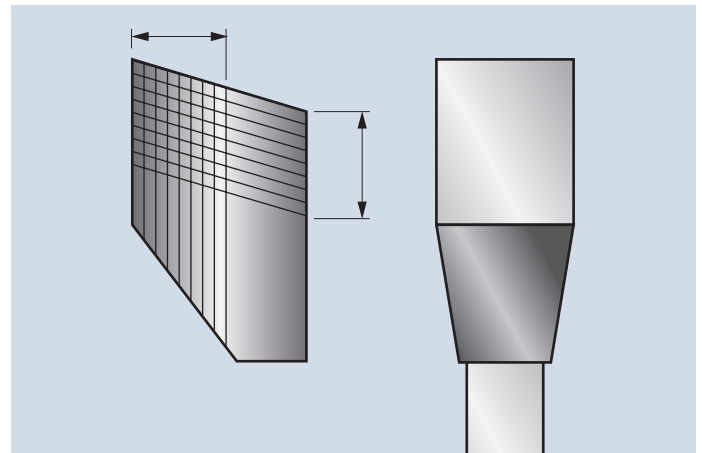

Supersquare tooth.
Superkvadratni zub.

Maximum durability: tri-metal shock resistant brazing

- Freud special tri-metal alloy consists of copper wrapped between layers of silver.
- This solution allows the Carbide tips to withstand extreme impact, for maximum durability.

Maksimalna izdržljivost: trimetalni izuzetno otporan sloj

- FREUD-ov specijalni trimetalni sloj sastoji se od bakra između dva sloja srebra.
- Ovakvo rešenje omogućava da Karbidni vrhovi mogu da podnesu ekstremne uslove i imaju maksimalnu trajnost.

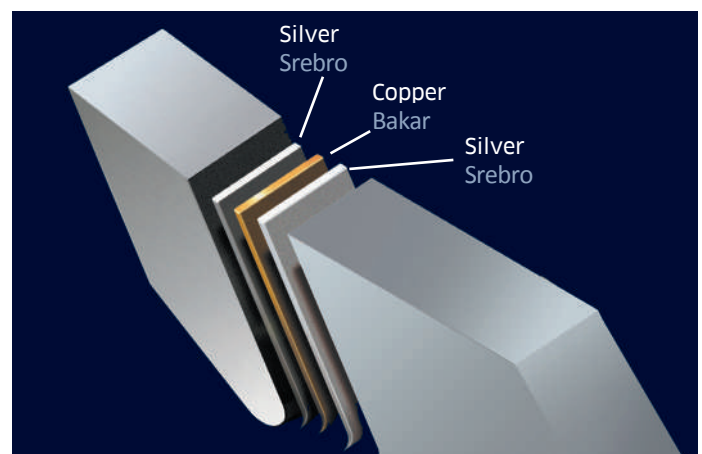

Tri-metal brazing.
Trimetalni sloj.

Superior finishing Superioran završni rez

A flawless result with no re-work
Besprekoran rezultat od prvog do
poslednjeg reza

Reduced friction: Silver I.C.E. Coating

- A high performing and anticorrosive coating to maintain the blade temperature low during the working process.
- The non-stick feature improves chip ejection and notably reduces resin build-up, significantly reducing friction and extending the life time of the blade.

Smanjeno trenje: Silver I.C.E. zaštitni sloj

- Antikoroziivni zaštitni sloj visokih performansi održava temperaturu testere nižom tokom rada.
- Nelepljivi sloj poboljšava radne karakteristike smanjenjem lepljenja piljevine, značajnim smanjenjem trenja i produžavanjem veka trajanja sečiva.



Silver I.C.E. coating.
Silver I.C.E. zaštitni sloj

GATECH
www.freud.rs

Improved precision: Anti-vibration slots for the perfect finishing

- Body slots laser cut with freud innovative technology.
- Also available with thermoplastic polyurethane filling, that considerably reduces vibration and minimizes noise.

Poboljšana preciznost: Antivibracioni prorezi za savršen rez

- Prorezi na telu testere laserski su usečeni uz pomoć inovativne FREUD-ove tehnologije.
- Prorezi su popunjeni termoplastičnim poliuretanskim materijalom, koji značajno smanjuje vibracije vibracije i buku.

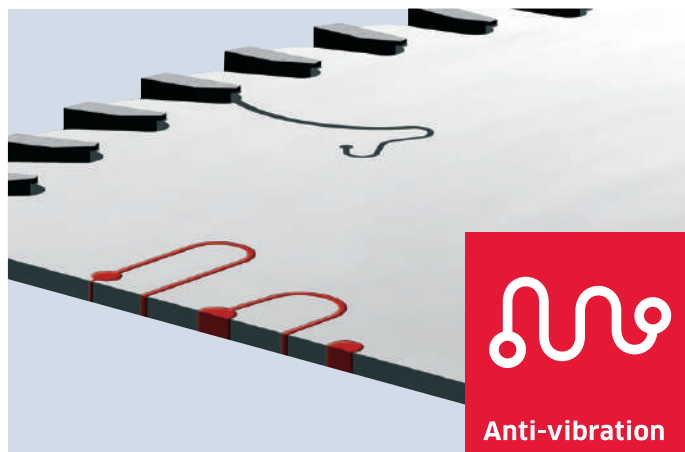

Section view of the antivibration slots.
Presek antivibracionih proseka

No blade distortion: laser cut steel, tensioning and balancing

- The high strength laser cut steel extends the blade durability, whereas the tensioning process guarantees maximum precision.
- An automated system balances freud blades one by one, eliminating completely the harmful vibrations.

Nema krivljenja testere: laserski sečen čelik, zategnut i balansiran

- Izuzetno izdržljiv laserski sečen čelik produžava vek trajanja testere, dok proces zatezanja garantuje maksimalnu preciznost.
- Automatizovan sistem balansira sve FREUD testere. eliminišući potpuno štetne vibracije.

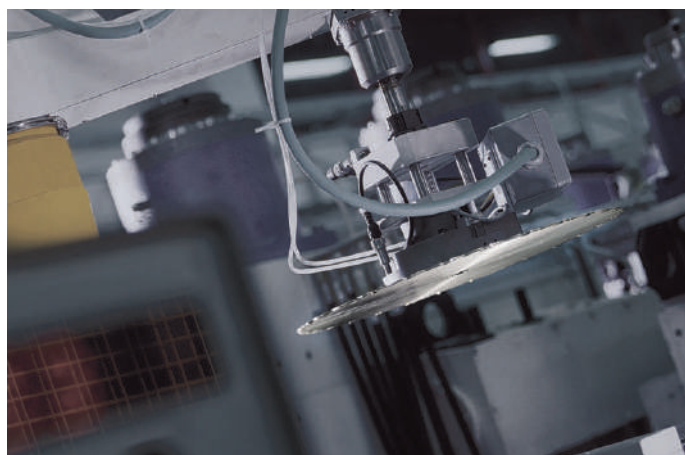

Balancing.
Balansiranje.

Circular saw blades for INDUSTRIAL MACHINES

Kružne testere za INDUSTRIJSKE MAŠINE

Choose the right tool
Izaberite odgovarajući alat

* LM10 - Only softwood

* LM10 - Samo meko drvo











Suitable for / Odgovarajuće za	PERFORMANCE / PERFORMANSE		
	Ultimate Najbolja	High Odlična	Good Dobra
 Multi-rip saw blades for ripping Testere za višelične cirkulare - uzdužan rez  Ripping Uzdužan rez  Cross cutting Poprečan rez  Ripping and cross cutting Uzdužan i poprečan rez	LM01 - LM10*	LM02-LM03-LM04-LM05- LM06-LM07-LM08	
	LU1F-LU1G	LU1C-LU1D-LU1E-LU2A- LU2B-LG1C	
	LU2A-LU2B-LU2C- LU2D-LU2F	LU2E-LG2C	LU1A-LU1E
		LG2A-LG2B-LU1H	LU1B
 Saw blades for cutting laminates Testere za rezanje laminata  Scoring saw blades for laminates Predrezači za laminate	LSB X LSB-LU3A-LU3B-LU3C- LU3D-LU3E-LU3F	LG3D	
	LI13MD-LI13MS-LI14MD- LI14MS-LI16M-LI17M- LI20M-LI22MD-LI22MS- LI25M-LI27M		
 Wood composites Drveni kompoziti	LSB X LSB-LU2C-LU2D-LU2E-LU2F- LU3A-LU3B-LU3C-LU3D-LU3F	LU2A-LU2B-LU3E- LG2A-LG2B-LG2C-LG3D	LU1E-LU1H
 Veneered Furnir	LU3A-LU3B-LU3C-LU3D- LU3E-LU3F	LG3D	
 Picture frames Ramovi	LU1I-LU1L		
 Non ferrous metals Obojeni metali	LU5F LU5A-LU5B-LU5C-LU5D- LU5E		
 Ferrous metals Crni metali	LU6A		
 Plexiglas Pleksiglas	LU4A-LU4B		
 Plastic materials Plastični materijali	LU5F LU4A-LU4B-LU5D-LU5B	LU2C-LU2D-LU2F- LG2C-LU3F	
 PVC PVC	LU5F	LU5B - LU5D	
 Solid surfaces Radne ploče	LU4D		

GATECH
www.freud.rs

Circular saw blades for PORTABLE MACHINES













Kružne testere za RUČNE CIRKULARE

Choose the right tool
Izaberite odgovarajući alat























Suitable for / Odgovarajuća za:	PERFORMANCE / PERFORMANSE		
	Ultimate Najbolja	High Odlična	Good Dobra
Solid wood Masiv	 Ripping Uzdužan rez	LP60M	
	 Cross cutting Poprečan rez	LP40M-LP60M	
	 Ripping and cross cutting Uzdužan i poprečan rez		LP20M-LP30M-LP60M LP70M
Laminated Laminati	 Saw blades for cutting laminates Testere za rezanje laminata	LP67M	LP85M-LP91M-LP40M
Wood composites Drveni kompoziti			LP91M LP40M
Veneered Furnir			LP91M
Non ferrous metals Obojeni metali		LP80M	LP85M-LP91M-LP40M
Ferrous metals Crni metali		LP90M	LP91M
Plexiglas & plastic materials Pleksiglas i plastični materijali			LP91M
PVC PVC			LP91M
Solid surfaces Radne ploče			LP91M

GATECH
www.freud.rs

Teeth shape varieties as applied to saw blades Vrste zuba po tipovima testera









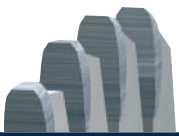

FLAT TOOTH RAVAN ZUB	DOUBLE TRIPLE CHIP TOOTH DUPLI TRAPEZNI ZUB	CONICAL TOOTH NAIZMENIČAN KOSI ZUB	BEVELLED TOOTH NAIZMENIČAN BW ZUB
LM01 - LM02 - LM05 - LM06 - LM07 - LM08 - LM10 - LU1E - LI20M - LI17M - LT18M - LT20M	LSC - LU4D - LU6A	LI25M	LU1B
			
Suitable for / Odgovarajući za:	Suitable for / Odgovarajući za:	Suitable for / Odgovarajući za:	Suitable for / Odgovarajući za:
 Ripping of softwood Legno tenero lungo vena	 Ferrous metals Metalli ferrosi	 Laminates (scoring saw blades) Laminati (lame incisore)	 Ripping and cross cutting of softwood Legno tenero lungo e trasverso vena
 Ripping of hardwood Legno duro lungo vena	 Solid surfaces Materiali polimerici		 Ripping and cross cutting of hardwood Legno duro lungo e trasverso vena
			 Chipboard Truciolare
			 Solid wood and composites with nails and impurities Legni e compositi con chiodi o impurità

GATECH
www.freud.rs











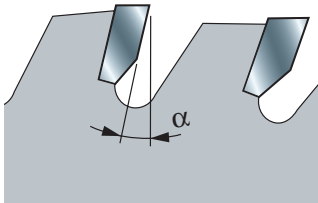

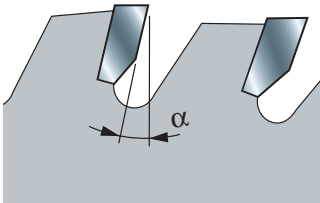

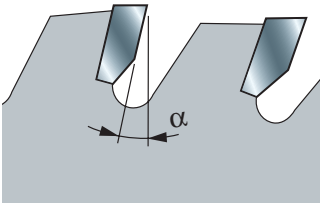

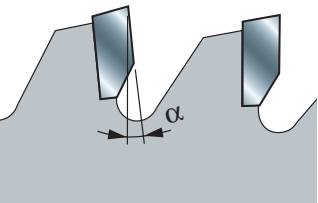

FLAT-TRIPLE CHIP TOOTH RAVAN - TRAPEZNI ZUB	INCLINED TOOTH KOSI ZUB	PYRAMID TOOTH PIRAMIDALNI ZUB	AXIAL TOOTH AKSIJALNI ZUB
LU3D - LU3E - LU3F - LG3D - LU4A - LU5A - LU5B - LU5C - LU5D - LU5E - LP40 - LP80 - LP90 - LP85 - LP91	LI22M - LI13M - LI14M - LT16M - LT12M - LT14M	LU5F	LU1L - LU4B
			
Suitable for / Odgovarajući za:	Suitable for / Odgovarajući za:	Suitable for / Odgovarajući za:	Suitable for / Odgovarajući za:
 Laminates / bilaminates Laminati / obostrano oplemenjeni pločasti materijali	 Cross cutting of softwood Poprečno rezanje mekog drveta	 PVC PVC	 Cross cutting of softwood Poprečno rezanje mekog drveta
 Chipboard Iverica	 Cross cutting of hard-wood Poprečno rezanje tvrdog drveta	 Non-ferrous metals Obojeni metali	 Cross cutting of hard-wood Poprečno rezanje tvrdog drveta
 MDF Medijapan (MDF)	 Laminates / bilaminates Laminati / obostrano oplemenjeni pločasti materijali		 Picture frames Ramovi za slike
 Plywood Furnir (šper)	 Plywood Furnir (šper)		 Plexiglas Pleksiglas
 Plexiglas Pleksiglas	 Scoring saw blades, for laminates Predrezači, za laminat		 Plastic materials Plastični materijali
 Plastic materials Plastični materijali			
 Non-ferrous metals Obojeni metali			

Teeth shape varieties as applied to saw blades

Vrste zuba po tipovima testera

CONCAVE TOOTH KONKAVNI ZUB	ROUNDED TOOTH ZAOBLJENI ZUB	ALTERNATE TOP BEVEL TOOTH NAIZMENIČNI BW ZUB
LU3B - LU3C	LU1G	LM03 - LM04 - LM08 - LU1A/C/D/F/H/I - LU2A/B/C/D/E/F - LU3A - LG1C - LG2A - LG2B - LG2C - LI16M LI27M - LP20M - LP30M - LP40M - LP60M - LP67M - LP70M
 <p>Suitable for / \</p>  <p>Laminates / bilaminates Laminati / obostrano oplemenjeni pločasti materijali</p>	 <p>Suitable for / \</p>  <p>Ripping of softwood Uzdužno rezanje mekog drveta</p>	 <p>Suitable for / \</p>  <p>Ripping and cross cutting of softwood Uzdužno i poprečno rezanje mekog drveta</p>  <p>Ripping and cross cutting of hardwood Uzdužno i poprečno rezanje tvrdog drveta</p>  <p>Chipboard Iverica</p>  <p>MDF Medijapan (MDF)</p>  <p>Plywood Furnir (šper)</p>  <p>Picture frames Ramovi za slike</p>

GATECH
www.freud.rs

HOOK ANGLES GRUDNI UGLOVI			
(α) 15° ÷ 25°	(α) 5° ÷ 15°	(α) 0° ÷ 5°	(α) 0° ÷ -10°
 <p>Suitable for / \</p>  <p>Cross cutting of softwood Poprečno rezanje mekog drveta</p>	 <p>Suitable for / \</p>  <p>Chipboard Iverica</p>	 <p>Suitable for / \</p>  <p>Chipboard Iverica</p>	 <p>Suitable for / \</p>  <p>Plexiglas Pleksiglas</p>
 <p>Cross cutting of hardwood Poprečno rezanje tvrdog drveta</p>	 <p>Plywood Furnir (šper)</p>	 <p>Non-ferrous metals Obojeni metali</p>	 <p>Plastic materials Plastični materijali</p>
 <p>Solid surfaces Kompaktni materijali (radne ploče)</p>	 <p>Laminates / bilaminates Laminati / obostrano oplemenjeni pločasti materijali</p>	 <p>Ferrous metals Crni metali</p>	 <p>Non-ferrous metals Obojeni metali</p>
	 <p>PVC PVC</p>		 <p>Laminates / bilaminates Laminati / obostrano oplemenjeni pločasti materijali</p>

LU4D

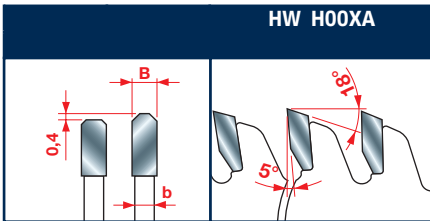

Tooth features - Karakteristike zuba

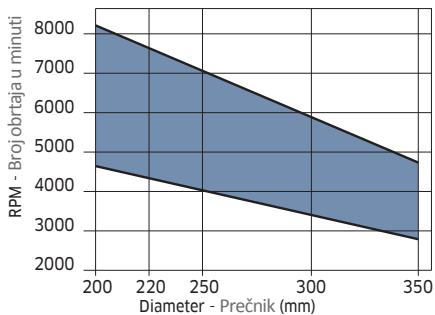

Minimum and maximum RPM based on the blade diameter.
Minimalan i maksimalan broj obrtaja u odnosu na prečnik testere.

HW - Saw blades to cut solid surfaces TM - Testere za rezanje radnih ploča

Saw blades optimized to cut solid surfaces boards.

Machines: Sliding table saws, miter saws.

Features: The special double triple chip tip grind and the thickness of the plate allow to get the best quality of cut in solid surfaces application. Moreover, they guarantee a longer lifetime versus standard products, despite the highly abrasive material.

Material: Solid surfaces, Corian boards and similar materials.

Testere dizajnirane za rezanje radnih ploča (Korijan...).

Mašine: Stabilni cirkulari sa kliznim stolom, gerovi.

Oblik zuba: Specijalni trapezni zubi sa dvostrukim i trostrukim ivicama i debljina ploče omogućavaju najbolji mogući kvalitet reza na tržištu kada su u pitanju radne ploče. Ove karakteristike garantuju i znatno duži radni vek od standardnih, uprkos velikoj poroznosti materijala.

Materijal: Radne ploče, Korijan table i slični materijali.

D	B	b	d	Z	NL	Code	SAP
mm	mm	mm	mm		Pomoćni otvori	Šifra	SAP
250	3,2	2,5	30	80	FT02	LU4D 0100	F03FS07294
300	3,2	2,5	30	96	FT02	LU4D 0200	F03FS07295
350	3,5	2,80	30	108	FT02	LU4D 0300	F03FS07296

GATECH
www.freud.rs

Ultimate	High	Good
Najbolja	Odlična	Dobra

Solid surfaces
Radne ploče



Table 1 Tabela 1

Saw blade's technical table to obtain the correct saw blade diameter based on its tip speed and the material to cut
Tabela za određivanje optimalnog prečnika testere prema perifernoj brzini i vrsti materijala za obradu

GATECH
www.freud.rs

Tip speed (m/s) Periferna brzina u m/s	Recommended for Preporučuje se za
50 - 90	Softwood / Meko drvo
50 - 80	Hardwood / Tvrdo drvo
50 - 85	Exotic wood / Egzotično drvo
60 - 80	Chipboard / Iverica
60 - 80	Joinery wood / Panel ploče
30 - 60	MDF / Medijapan (MDF)
40 - 60	Laminated and bilaminated / Oplemenjeni materijali

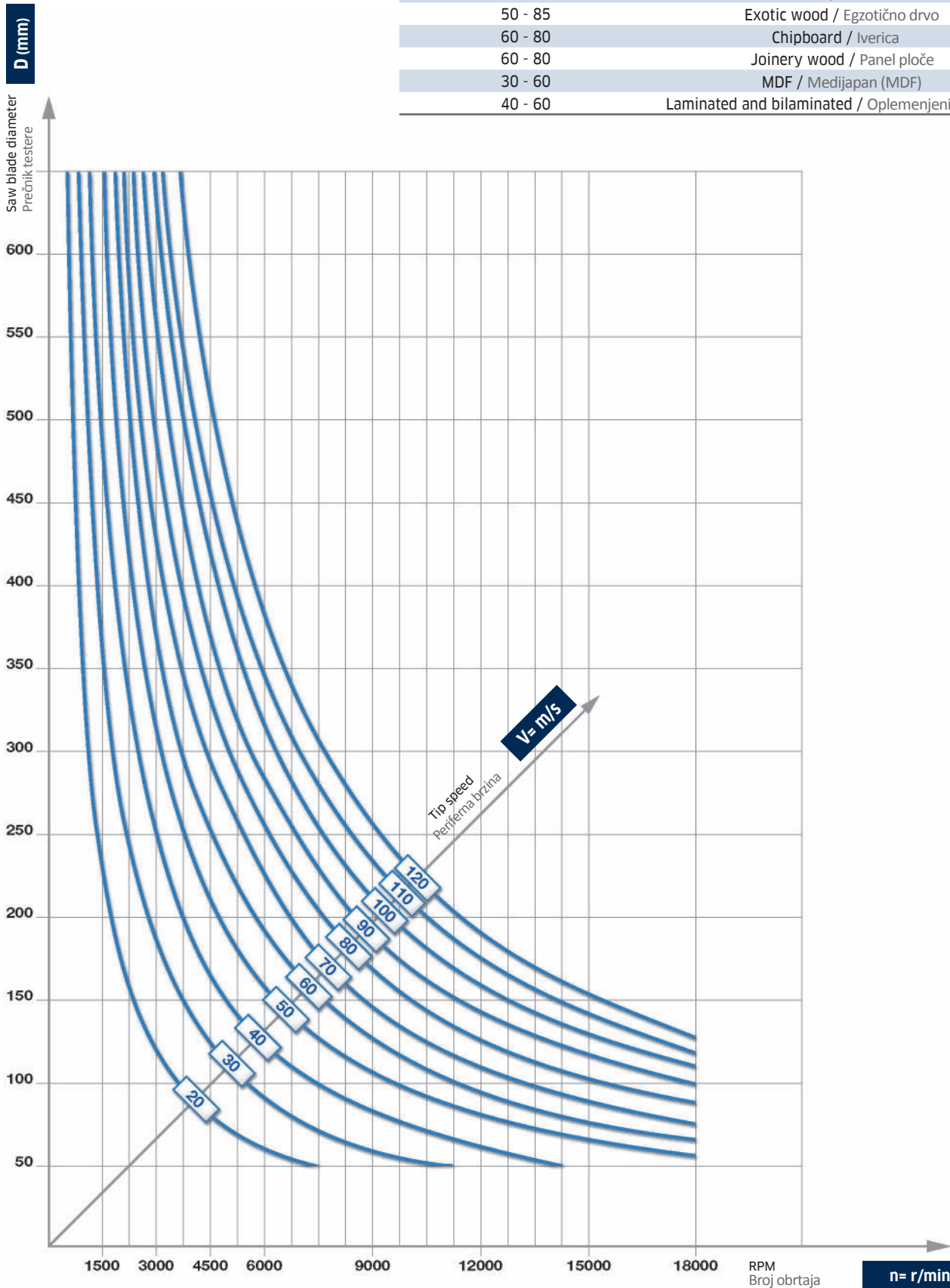
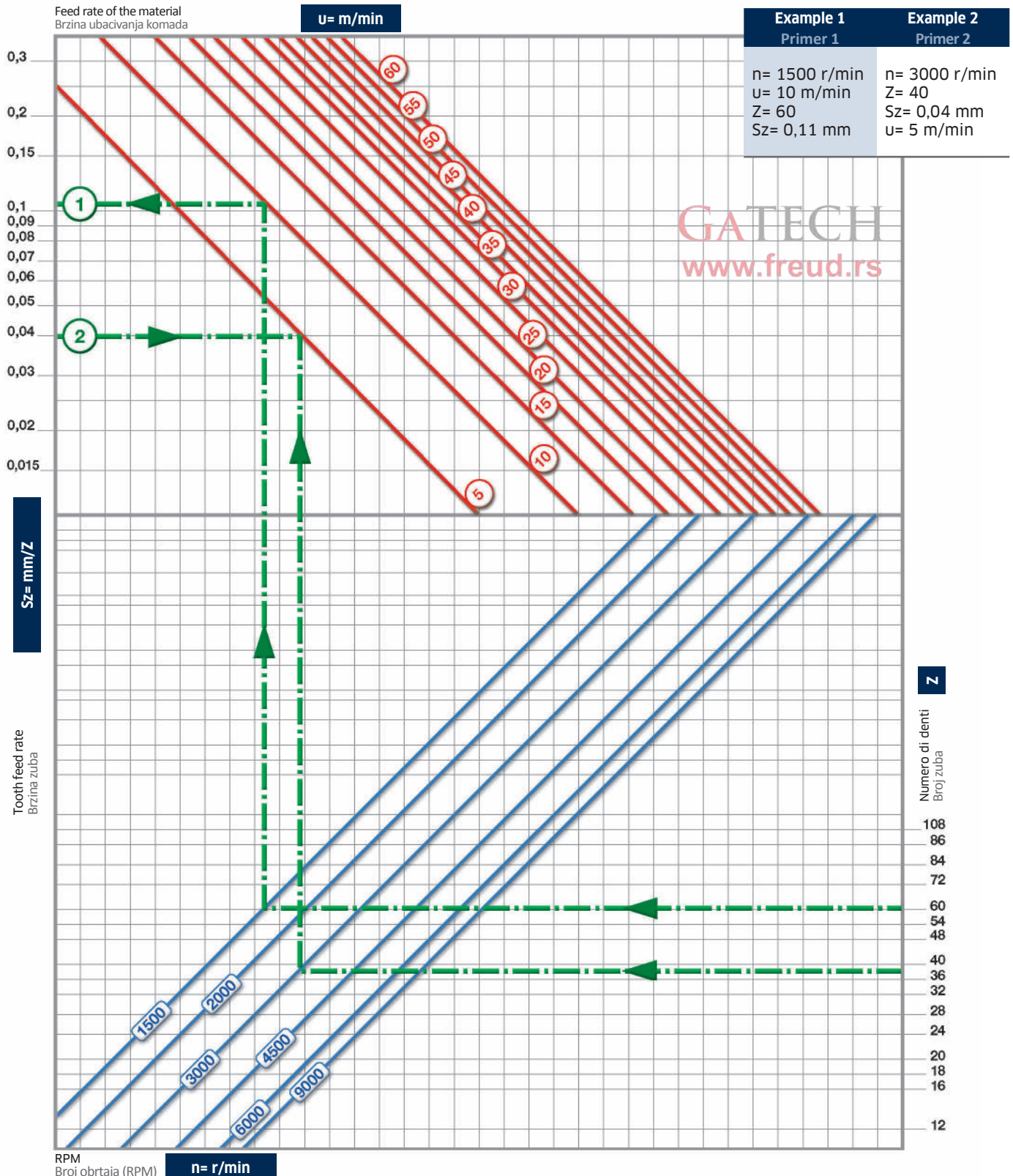

Table 2 Tabela 2

Saw blade's technical table to obtain the correct tooth feed rate, the feed rate of the material, the number of teeth and the RPM
Tabela za određivanje adekvatne brzine zuba, brzine ubacivanja komada, broja zuba i broja obrtaja (RPM)

Recommended tooth feed rate (Sz= mm/tooth) Preporučena brzina zuba (Sz= mm/zub)	Recommended for Preporučuje se za
0,20 - 0,30	Softwood ripping / Meko drvo uzdužno
0,10 - 0,20	Softwood crosscutting / Meko drvo poprečno
0,06 - 0,15	Hardwood / Tvrdo drvo
0,10 - 0,25	Chipboard / Iverica

Recommended tooth feed rate (Sz= mm/tooth) Preporučena brzina zuba (Sz= mm/zub)	Recommended for Preporučuje se za
0,05 - 0,12	Plywood / Šperploča
0,05 - 0,10	Laminated board / Oplemenjeni materijali
0,02 - 0,05	Aluminum and plastic laminated chipboard Aluminijum i laminati



GATECH
www.freud.rs

Explanation of symbols and abbreviations Pojašnjenje simbola i skraćenica

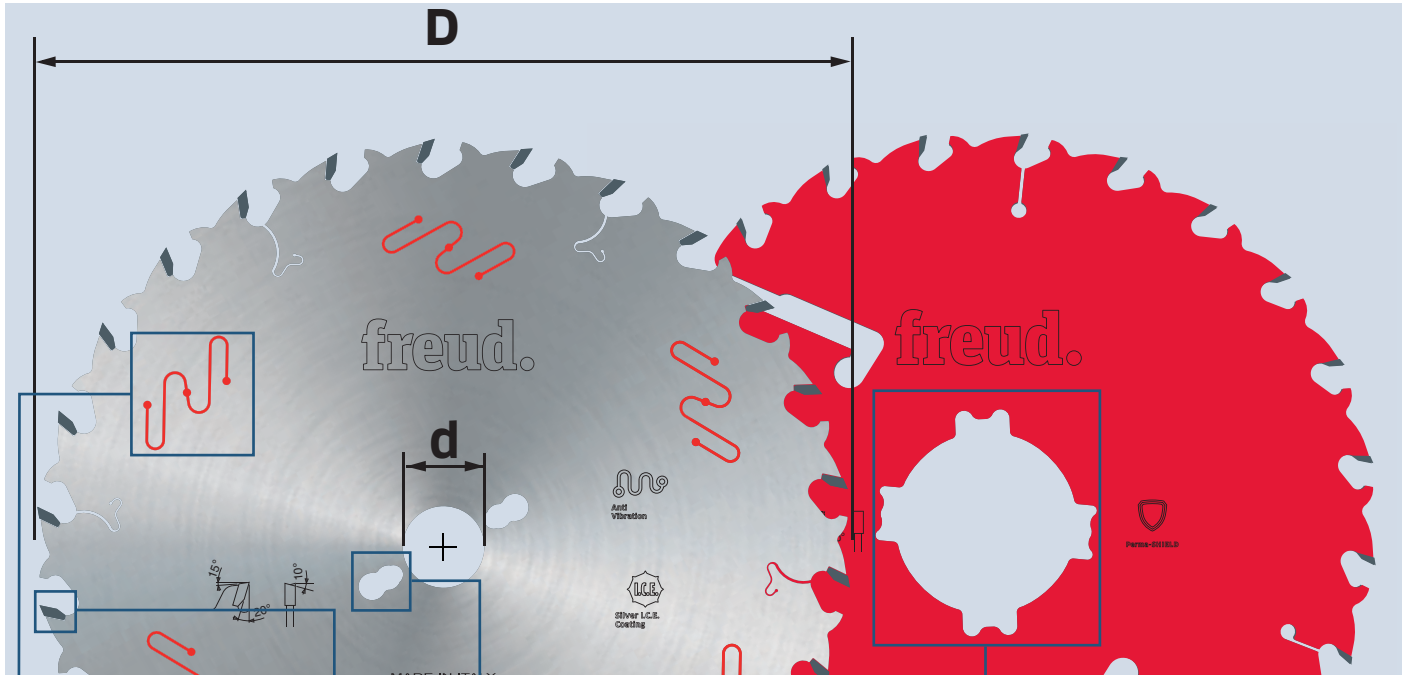

	D mm	B mm	b mm	d mm	Z	NL FT	KN CH	Code Codice	SAP SAP
	250	3,2	2,2	30	22	FT01		ABCD 1234	A00BC01234
	250	3,2	2,2	70	22	4CH 21x5		ABCD 1234	A00BC01234
	300	3,2	2,2	30	26	FT01		ABCD 1234	A00BC01234

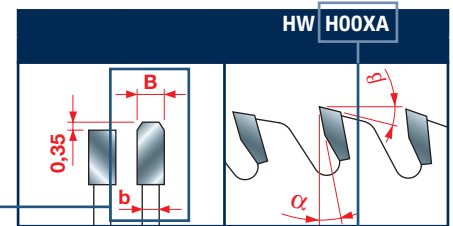

MICRO-GRAIN CARBIDE (HW) HARDNESS USED FOR MANUFACTURING TIPS
TVRDOĆA MIKRO-ZRNA KARBIDA (HW) KORIŠĆENOG ZA PROIZVODNJU ZUBA

Tooth features - Karakteristike zuba

← INCREASING IMPACT STRENGTH • VEĆA ELASTIČNOST
INCREASING HARDNESS • VEĆA TVRDOĆA →

TF30	K10S	H01K	H00K	H00XA	H00XF
1515 9,8 11,75	1620 8,94 14,35	1870 8,22 14,36	1930 7,68 14,71	2070 7,71 14,73	2200 7,73 14,63

Vickers hardness • Tvrdća (HV10)

Transverse rupture • Tenzija (K1c)

Density • Gustina (gr/cm³)

TiCo Carbide

Explanation of symbols and abbreviations

Pojašnjenje simbola i skraćenica

GATECH
www.freud.rs





PERFORMANCE		
Ultimate Najbolja	High Odlična	Standard Dobra
●		

CHART ABOUT THE SAW BLADE'S PERFORMANCE
TABELA PERFORMANSI TESTERA

SYMBOLS TO READ THE PRODUCT TABLES SIMBOLI POTREBNI ZA TUMAČENJE TABELA PROIZVODA

D	Diameter Prečnik	d	Central bore Centralni otvor	α	Hook angle Grudni ugao
B	Cutting thickness Debljina reza	Z	Number of teeth Broj zuba	B R	Back relief angle Ledni ugao
B-B1	Adjustable cutting thickness Podesiva debljina reza	KN CH	Keyways Otvori za klinove	Code Codice	Item code Šifra artikla
b	Saw blade body thickness Debljina tela testere	NL FT	Pin holes Pomoćni otvori	SAP SAP	Item code - for SAP users only Šifra artikla - samo za klijente SAP

OTHER SYMBOLS ALTRI SIMBOLI

	Silver I.C.E. Coating Silver I.C.E. zaštitni sloj		Multi-rip saw blade for ripping of softwood Testera za uzdužno rezanje mekog drveta na višelisnim cirkularima		Saw blade to cut solid wood and composites with nails and impurities Testera za rezanje masiva i kompozita sa ekserima i nečistoćama
	Perma-SHIELD coating Perma-SHIELD zaštitni sloj		Multi-rip saw blade for ripping of hardwood Testera za uzdužno rezanje tvrdog drveta na višelisnim cirkularima		Saw blade to cut laminates Testera za rezanje laminata
	Anti-vibration technology Antivibraciona tehnologija		Saw blade for ripping of softwood Testera za uzdužno rezanje mekog drveta		Saw blade to cut veneered Testera za rezanje furnira
	Saw blade for miter saws Testera za ger		Saw blade for ripping of hardwood Testera za uzdužno rezanje tvrdog drveta		Scoring saw blade Predrežac
	Saw blade for portable machines Testera za prenosne cirkulare		Saw blade for ripping of softwood Testera za uzdužno rezanje mekog drveta		Saw blade to cut picture frames Testera za rezanje ramova
	Right hand or left hand Desni ili levi smer kretanja		Saw blade for ripping of hardwood Testera za uzdužno rezanje tvrdog drveta		Saw blade to cut PVC Testera za rezanje PVC-a
	Tools for automatic feed Alati za automatsko dodavanje		Saw blade for cross cutting of softwood Testera za poprečno rezanje mekog drveta		Saw blade to cut plastic materials Testera za rezanje plastičnih materijala
	Disposable knives Izmenjive pločice (nožići)		Saw blade for cross cutting of hardwood Testera za poprečno rezanje tvrdog drveta		Saw blade to cut plexiglas Testera za rezanje plexiglasa
			Saw blade for ripping and cross cutting of softwood Testera za uzdužno i poprečno rezanje mekog drveta		Saw blade to cut solid surfaces Testera za rezanje radnih ploča
			Saw blade for ripping and cross cutting of hardwood Testera za uzdužno i poprečno rezanje mekog drveta		Saw blade to cut non-ferrous metals Testera za rezanje aluminijuma i obojenih metala
			Saw blade to cut wood composites Testera za rezanje drvenih kompozita		Saw blade to cut ferrous metals Testera za rezanje gvožđa i crnih metala

Tips for the correct use of a saw blade

Saveti za ispravno korišćenje testere

Tips for the correct use of a saw blade

Saveti za ispravno korišćenje testere

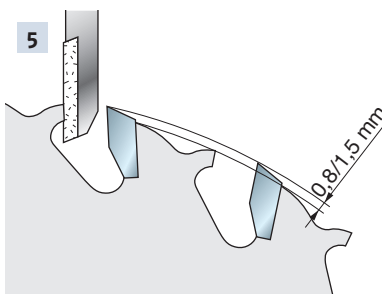
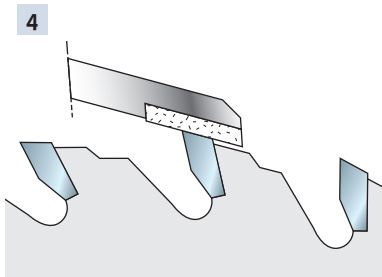
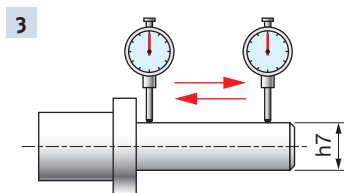
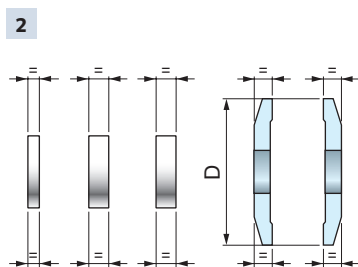
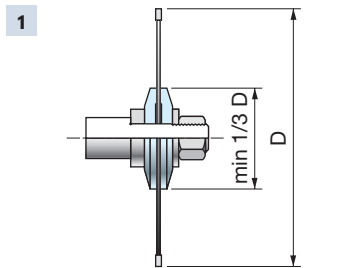

To obtain the best performance from a saw blade we suggest to follow these simple instructions:

- The machine must be in good condition, free of vibrations.
- The flanges used to secure the blade must be of the same diameter, at least 1/3 of the blade's diameter (Fig. 1).
- The flanges must be parallel to each other. Also check tolerances on diameters, sides and concentricity, by using a clock gauge (Fig. 2).
- The spacers must be perfectly parallel (Fig. 2).
- The spindle must be perfectly straight and with an H7 tolerance (Fig. 3).
- After continuous use, remove the blade and clean it with the appropriate solvents making sure to get rid of built up resin. For the synthetic coated (perma-SHIELD) blades, it's sufficient to use warm water. In any case, avoid using solvents containing caustic soda.
- The blades must be sharpened as soon as they become dull, maintaining the original tooth angles.
- For sharpening, always use the correct grinding wheels and plenty of cooling liquid.
- Always keep spacers and flanges clean.
- When sharpening, the shoulder of the teeth must not be lowered more than needed. This operation must be done with appropriate precision machinery and never by hand. There is the risk of breaking the tip or upsetting the blade balance (Fig. 4 - 5).
- On ripping machines, the feeding track must be levelled with the fixed table.
- Before starting the cut of the material, make sure the blade is correctly locked according to the machine's specifications.

Da biste iskoristili najbolje performanse testere, predlažemo Vam da pratite ova jednostavna uputstva:

- Mašina na kojoj radite mora biti u dobrom stanju, bez vibracija.
- Flanšne kojima se steže testera moraju biti istih dimenzija, otprilike minimum 1/3 prečnika testere (Slika 1).
- Flanšne za stezanje moraju biti paralelno postavljene. Proverite da li su dobro postavljene i pričvršćene pre započinjanja radova (Slika 2).
- Distantni prstenovi moraju biti savršeno paralelni (Slika 2)
- Osovina mora biti ravna i u toleranciji h7 (Slika 3).
- Nakon duže upotrebe, skinite testeru sa mašine i operite je odgovarajućim sredstvom da biste sprečili nagomilavanje otpadaka po njoj. Za testere sa sintetičkom (perma-SHIELD) prevlakom, dovoljno je da upotrebite toplu vodu. U svakom slučaju, izbegavajte upotrebu rastvora koji u sebi sadrže kaustičnu sodu.
- Naoštrite testere čim primetite da su tupe, zadržavajući originalne uglove zuba.
- Prilikom oštrenja uvek koristite odgovarajuće brusne ploče i dovoljno tečnosti za rashlađivanje.
- Vodite računa da distantni prstenovi i prirubnice budu uvek čisti.
- Telo iza zuba ne sme se spuštati više nego što je potrebno i to se nikada ne sme raditi ručno, jer postoji opasnost od lomljenja vrha i gubitka pravilnog balansa testere (Slike 4 - 5)
- Na višelisnim cirkularima, vučni valjci moraju biti u ravni sa fiksnim delom stola.
- Pre početka rezanja proverite da li je testera dobro fiksirana u skladu sa specifikacijama mašine.

GATECH
www.freud.rs

Tips for the correct use of a saw blade

Saveti za ispravno korišćenje testere

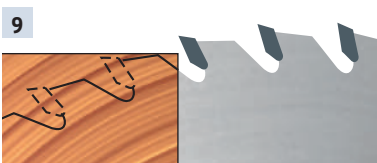
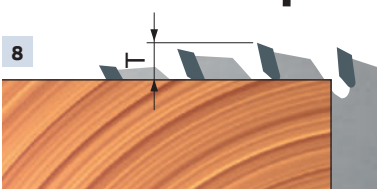
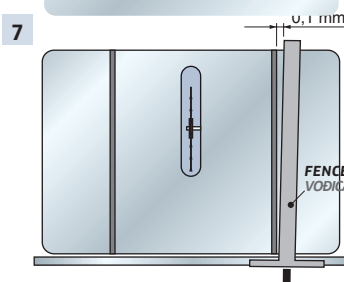
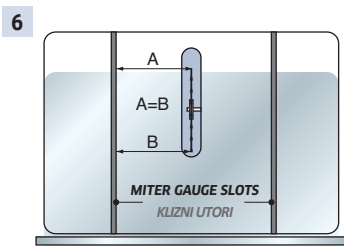

SAW BLADE ALIGNMENT ON A TABLE SAW

- If the saw blade and the saw are not correctly aligned to the table and the fence, then there is the possibility that a serious accident may occur (for example, violent kickbacks) or that the workpiece may scorch or splinter. The first thing you must do is read the instruction sheet carefully. This is necessary so as you may acquire the understanding and comprehension of the corrections suggested in this section.
- Before carrying out the following instructions, make sure that the starter switch is off and that the machine is not connected to the socket.

Mounting the saw blade onto the table:

We advise you to use precise measuring instruments when mounting your saw blade. Clean the saw blade well, before mounting it onto the machine. Mount the saw blade onto the arbor. Adjust the arbor to its maximum height. With the aid of the most precise measuring instrument available, verify that the saw blade is parallel to the miter gauge slots (Fig. 6). Adjust as needed. This step is necessary to obtain crosscuts with the maximum in quality finish and for setting up the fence for ripping.

Positioning the fence for ripping:

After having positioned the saw blade so as it is parallel to the miter gauge slots, you may proceed with setting the fence. The fence should ideally be parallel to the saw blade. However since it is impossible to position the guide "exactly" it is necessary to leave a slight margin of clearance on the exit side of the cut so as to avoid the wood becoming wedged in between the fence and the saw blade.

Adjust the fence so as when it is aligned to the miter gauge slots, there is a space of 0,1 mm (fig. 7; for the correct adjustment, consult the machine's instruction manual).

- The maximum RPM of a circular saw blade varies according the diameter of the blade itself (table 1). If you exceed this limit, the saw blade will lose its characteristics, therefore influencing the cutting quality and the work life of the blade itself, not to mention the dangers implied to the user who may incur serious injury.
- The saw blade's projection (T) with respect to the workpiece must be at least equal to the height of the blade's tooth (fig. 8). Increase or decrease the projection of the saw blade to improve the quality of the cutting finish.
- The number of teeth cutting (teeth cutting the wood simultaneously - fig. 9) must be between 3 or 4. With less than three teeth cutting, the saw blade begins to vibrate leading to an uneven cut. If you want to cut workpieces with increased thicknesses (S - fig. 11), but wish to maintain the same diameter saw blade, then use a blade with less teeth. If instead you want to cut workpieces with a reduced thickness, but also maintain the same diameter saw blade, then use a blade with more teeth.

Table 1 - Tabela 1

Saw blade diameter Prečnik testere	Maximum RPM Max OBRTAJA/MIN
100 mm	23.000
125 mm	18.000
150 mm	14.500
180 mm	11.500
185 mm	11.000
200 mm	10.000
225 mm	8.500
250 mm	8.000
255 mm	7.800
280 mm	7.100
300 mm	6.500
320 mm	6.000
350 mm	5.500
380 mm	5.000
400 mm	4.700
430 mm	4.400
450 mm	4.200
500 mm	3.750
550 mm	3.400
600 mm	3.100
630 mm	2.950
650 mm	2.800
700 mm	2.600
730 mm	2.500
760 mm	2.400
800 mm	2.250

Not valid for saw blades to cut ferrous metals.

Nije validno za testere za rezanje gvožđa i crnih metala.

POSTAVLJANJE TESTERE NA MAŠINU

- Ukoliko testera i mašina nisu pravilno postavljene u odnosu na sto i vođicu, može doći do ozbiljnih nezgoda (npr, odskakanja komada) ili se komad može oštetiti. Prva stvar koju morate uraditi jeste da pažljivo pročitate uputstvo za rukovanje mašinom. Zahvaljujući tome, moći ćete i da razumete i primenite savete koje Vam u ovom delu kataloga dajemo.

- Pre primene saveta koje Vam dajemo, proverite da li je mašina isključena i da nema dovoda struje.

Postavljanje testere na sto:

- Savetujemo Vam da koristite tačne merne instrumente kada postavljate testeru. Pre postavljanja, testeru koja je radila dobro očistite. Postavite testeru na osovinu i dovedite je na maksimalnu visinu. Uz pomoć preciznog mernog instrumenta proverite da li je testera paralelna sa kliznim utorima (Slika 6). Podesite je na taj način. Ovaj korak je neophodan da bi se dobili poprečni rezovi maksimalnog kvaliteta završnog reza i da bi se postavila vođica za uzdužan rez.

Postavljanje vođice za poprečan rez:

- Kada ste postavili testeru paralelno sa kliznim utorima, možete pristupiti podešavanju vođice. Vođica bi u idealnim uslovima trebalo da bude paralelna sa testerom. Međutim, kako je nemoguće postaviti vođicu „apsolutno tačno“, potrebno je ostaviti malu marginu na izlaznoj strani reza da bi se izbeglo zaglavljivanje komada između vođice i testere. Podesite vođicu tako da bude otprilike oko 0,1mm između nje i kliznih utora (Slika 7). Za tačno podešavanje, pogledajte uputstvo koje ste dobili uz mašinu.
- Maksimalan broj obrtaja testere (RPM) zavisi od prečnika testere (Tabela 1). Ukoliko se ove vrednosti pređu, testeraće izgubiti svoja svojstva, što će direktno uticati na kvalitet reza i vek trajanja testere – da ne spominjemo i opasnost od povreda koje se mogu desiti ukoliko se testera ošteti.
- Projekcija testere (T) mora biti takva da ona bude viša (viri iz materijala) barem za visinu zuba (Slika 8). Smanjenje ili povećanje te visine uticaće na kvalitet završnog reza.
- Broj zuba koji se istovremeno nalaze u zahvatu (Slika 9) mora biti između 3 i 4. Ukoliko istovremeno kroz komad prodire manje od 3 zuba, testera počinje da vibrira i doći će do neravnomernog rezanja. Ukoliko želite da režete komad povećane visine (S – Slika 11), ali želite da zadržite istu dimenziju testere, koristite testere sa manjim brojem zuba. Ukoliko želite da režete komad manje visine, uz zadržavanje iste dimenzije testere, odlučite se za tetesru sa većim brojem zuba.

Tips for the correct use of a saw blade

Saveti za ispravno korišćenje testere

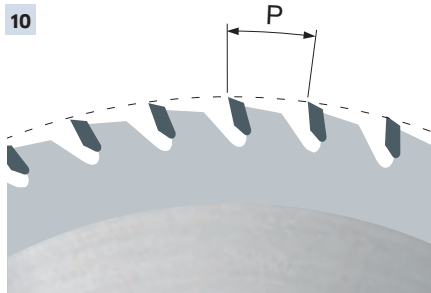

- To obtain the pitch (**P**) of a blade (the distance between teeth: fig. 10 - (see formula "a") multiply the thickness of the workpiece by 1,4142 and divide by 3 (if you want 3 teeth cutting) or by 4 (if you want 4 teeth cutting).
- Formula "b": to obtain the number of teeth (**Z**) of the saw blade, multiply the diameter (**D**) of the saw blade by 3,14 (π) and divide by the pitch of the saw blade - obtained from the previous formula. The shorter formula "c" allows you to obtain the nr. of the saw blade's teeth, knowing its diameter and the thickness of the workpiece.
- Korak (**P**) je udaljenost između zuba (Sl. 10). Da biste ga dobili (vidi formulu "a"), pomnožite debljinu komada sa 1,4142 i podelite s 3 (ako želite 3 zuba u zahvatu) ili 4 (ako želite 4 zuba u zahvatu).
- Formula "b": za dobijanje broja zuba (**Z**) testere, pomnožite njen prečnik (**D**) s 3,14 (π) i podelite s korakom (**P**) dobijenim u prethodnoj formuli. Kraća formula "c" omogućava da se dobije potreban broj zuba testere koristeći samo njen prečnik i debljinu komada koji se reže.

Formula A	Formula B	Formula C
$P = \frac{S \times 1,4142}{3}$	$Z = \frac{D \times 3,14}{P}$	$Z = \frac{D \times 8}{S}$

KEY:

LEGENDA:

P=pitch / korak

S=thickness of the workpiece / debljina komada

Z=nr. teeth of the saw blade / broj zuba testere

D=diameter of the saw blade / prečnik testere

ATTENTION:

These formulas are valid for crosscutting and cutting other wood composites of (MDF, plywood, chipboard and laminated panels) and cannot be applied for ripping.

PAŽNJA:

Ove formule su validne za poprečno rezanje drveta i pločastih materijala (medijapana MDF, iverice, šper ploče i laminata) i ne mogu se primeniti na uzdužno rezanje.

GATECH
www.freud.rs

Tips for the correct use of a saw blade

Saveti za ispravno korišćenje testere

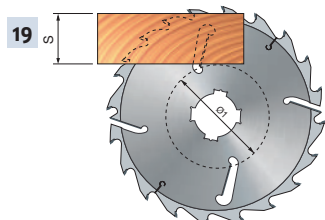
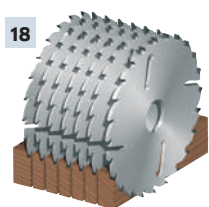
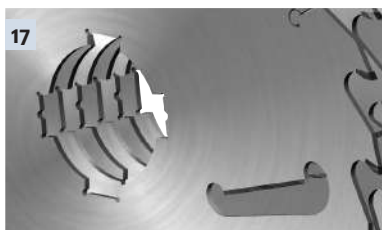
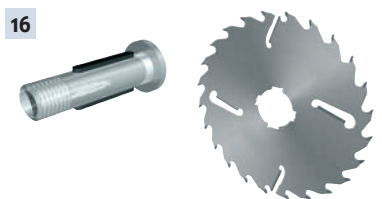
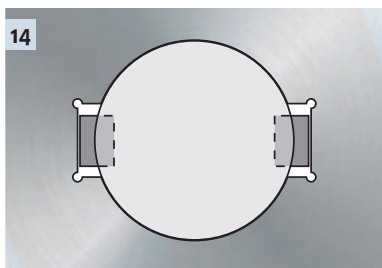
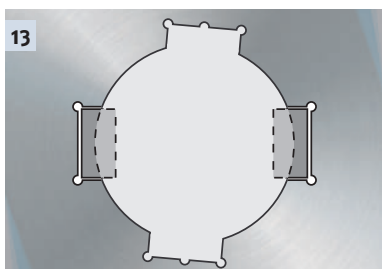
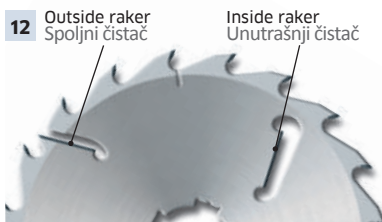

- Rakers (Fig. 12) are inserts in HW that are brazed onto saw blades exclusively for cutting wood. They help keep a distance between the saw blade body and the workpiece, in order to avoid friction and overheating which cause the blade to deform.
- On saw blades for multiripping machines the anti kick-back device is advised in cases where wood has loose knots and discards cases insert themselves underneath the saw blade.
- The pairing of blade and arbor with keyways is excellent in all cases where the keyways are the same (Fig. 13) or smaller then the blade slots (Fig. 14).
- On machines with an arbor with 1 keyway, you can only mount blades with 1 keyway slot (Fig. 15); on machines with an arbor with 2 keyways, you can only mount blades with 2 or 4 keyway slots (Fig. 16).
- You cannot mount a saw blade with 2 keyways on an arbor with 1 keyway slot, because the pairing will not be balanced.
- In case multiripping saw blades are used, it is recommendable to assembly them with alternate keyways (Fig. 17).
- Shoulder blade ensures correct distribution of lateral forces created by crooked planks in heavy duty use. The shoulder blade must be the first blade on the guide side of the multiripping machine.
- Always use shoulder blade with the set of multiripping blades (Fig. 18).
- On multiripping saw blades, the thickness of the workpiece (S) varies according to the diameter of the blade (Ø) and the minimum diameter (Ø1) of the rakers (the rakers position may vary from blade to blade - Fig. 19).

- Čistači (Slika 12) su TM pločice koje su lemljene na telo testera isključivo za rezanje drveta. Koriste se za odvajanje drveta od tela alata, kako bi se izbeglo trenje i pregrevanje što uzrokuje deformaciju testere.
- Na testerama za višelisne cirkulare, preporučuje se upotreba stezača protiv odskakanja komada, posebno u slučajevima kada drvo ima čvorove i kada se može desiti da ostaci komada koji se reže upadnu ispod testere.
- Pričvršćivanje testera za osovinu najbolje je kada postoje otvori koji odgovaraju dimenzijama klinova (Slika 13) ili su malo veći od dimenzija klinova (Slika 14).
- Na mašine čija osovinu ima jedan klin mogu se montirati samo testere koje imaju jedan otvor za klin (Slika 15), a na mašine čija osovinu ima dva klina mogu se montirati testere koje imaju dva ili četiri otvora za klinove (Slika 16).
- Testera sa dva otvora za klin ne može se montirati na osovinu sa jednim klinom, jer ne bi mogla dobro da se balansira.
- Ukoliko se vrši postavljanje više testera za višelisne cirkulare odjednom, preporuka je da se to radi tako što će se svaka od testera pomeriti za po jedan otvor u odnosu na prethodnu (Slika 17).
- Krajnja testera na višelisnim cirkularima mora biti jača od ostalih i postavlja se kao prva na ulaznoj strani komada. Ona osigurava pravilnu distribuciju lateralnih sila prilikom obrade komada.
- Uvek koristite krajnju testeru u setu testera za višelisni cirkular (Slika 18).
- Kada su u pitanju višelisni cirkulari, debljina komada (S) zavisi od prečnika testere (Ø) i minimalnog prečnika (Ø1) čistača (njihov položaj može varirati od testere do testere (Slika19).

GATECH
www.freud.rs